

Air Transport & Travel Industry

Functional and Business Principles

PNRGOV

Version 17.1

Table of Contents

1	INTRODUCTION.....	3
	PURPOSE.....	3
	SCOPE.....	3
	BACKGROUND.....	3
	REFERENCES.....	3
	ASSUMPTIONS AND CONSTRAINTS.....	4
1.1	<i>Assumptions.....</i>	4
1.2	<i>Constraints.....</i>	4
1.3		4
1.4	DOCUMENT OVERVIEW	4
1.5		
^{1.5.1} _{1.5.2}	PRINCIPLES	5
1.6 ³	FUNCTIONAL AND BUSINESS REQUIREMENTS	8
3.1	BUSINESS REQUIREMENTS	8
3.1.1	<i>Multi-Leg Flights (multiple departure points using the same flight number)</i>	8
3.1.2	<i>Multiple State Requirements</i>	10
3.1.3	<i>Multiple System Interaction</i>	11
3.1.4	<i>Overflights.....</i>	11
3.1.5	<i>Operating Carrier v Marketing Identification and Message Structure</i>	11
3.1.6	<i>Message Sizing.....</i>	11
3.1.7	<i>PCI – DSS Compliance</i>	11
3.1.8	<i>PNR Data Elements.....</i>	11
3.1.9	<i>Context</i>	13
3.2	FUNCTIONAL REQUIREMENTS	15
3.2.1	<i>Data submission.....</i>	15
3.2.3	<i>Provision of an Ad-hoc request using the GOVREQ message</i>	16
3.2.4	<i>Separate Operational Systems – DCS without full PNR access</i>	16
3.2.5	<i>Management of outages</i>	17
3.2.6	<i>Manual DCS operations.....</i>	17
3.2.7	<i>Irregular operations.....</i>	17
3.2.8	<i>Reservation & Departure Control system integration</i>	17
3.2.9	<i>Infant Data in the PNRGOV message.</i>	23
4	MODES OF TRANSMISSION.....	24
5	APPENDIX A - GLOSSARY	25

1 INTRODUCTION

This document is intended to provide guidance to airlines, System Suppliers and States who are implementing the PNRGOV message. The information contained in this document should be utilized in conjunction with the current PNRGOV implementation Guide. This document is a living document and will be updated for any future requirements / principles as agreed by the Working Group.

The PNRGOV message is designed to comply with States' Legislation for the provision of PNR data from Carriers.

Purpose

- The purpose of this document is to clearly define the business requirements, Functional requirements and the underlying principles for the PNRGOV message. This document is
- 1.1 a living document which although under version control does not require PADIS Board approval for any future changes / updates.

Scope

- 1.2 The scope of this document is to provide relevant information in conjunction with the implementation guide to ensure a consistent approach to implementation. It will also identify, where necessary, any bilateral agreements that need to be implemented for the usage of the PNRGOV message.

This document, although targeted at the implementation of the EDIFACT message, will also serve as a reference point for the development of the XML PNRGOV message.

1.3 Background

The PNRGOV message has been developed under the auspices of the PADIS Board. The message structure and the contents of the message are designed to provide a consistent approach for all airlines required to provide PNR information to States. Although not mandated for usage, currently it is envisaged that the message may provide the opportunity to rationalize data provision in the future. Within this document, Governments are referred to as States and Airlines as Carriers.

- 1.4 The basis for the development of the PNRGOV message was PADIS Standard v08.1

References

PADIS Codeset Directory

PADIS Message Standards

ICAO Doc 9944 Guidelines on Passenger Name Record (PNR) Data

Payment Card Industry – Data Security Standards (PCI – DSS)

<https://www.pcisecuritystandards.org/index.shtml>

Assumptions and Constraints

Assumptions

It is assumed that the message structure provided is the same for all States and that there are no additional requirements beyond those clearly identified within this document or in 1.5 the associated Implementation Guide. It is further assumed that, through bilateral agreement, States will publish individual Implementation Guides conforming to said 1.5. States legislative and regulatory authorities.

The basis for the legal provision of data required by any State is described in ICAO *Doc 9944 Guidelines on Passenger Name Record (PNR) Data* document.

Constraints

- 1.5.2 • Only data available in the operating Carriers' systems is passed to the States. There is no mandate for the provision of additional data not presently stored or provided within the systems.
- In line with the PCI –DSS requirements, standards for the storage of credit card details can be found at <https://www.pcisecuritystandards.org/index.shtml>. According to applicable laws, individual States expect to receive credit card details and thus the delivery method and any encryption needed must be addressed between States and Carriers. See section 3.1.7 for further details
- The protocol for message delivery depends on the capability of the States and Carriers. The protocol to be used is agreed on a bilateral basis.

1.6

Document Overview

This document addresses 3 key areas for the structure and delivery of the PNRGOV message. These are

1. **Principles** – This section provides guidance for all Carriers and States wishing to implement PNRGOV and identifies specific entities and other resources which provide guidance for usage and/or delivery. It also addresses the availability of data.
2. **Business Processes** – This section identifies the areas of the PNRGOV message which need to be managed according to the limitations of the data held by the operating Carrier and the data requirements of the States.
3. **Functional Processes** – This section provides an overview of the functional requirements of the States regarding submissions of data and system interaction.
4. **Modes of transmission**

Note: Any examples supplied in this document may use real port, country names or codes to enhance readability, but these may have no link to the actual rules in force at those locations at the time of reading.

2 PRINCIPLES

In order to provide a consistent approach to the provision of the PNRGOV message and the data that it might contain, a number of principles have been identified and should be adhered to, where possible. These principles include but are not limited to:

1. Carriers are responsible for the provision of PNR data (reservation data and check-in data when available). This data is transmitted by means of an automated process enabling “machine to machine” interface. The information may be transmitted by the Carrier or a service provider.
2. Messages are constructed in accordance with the PNRGOV structure as documented in the current PNRGOV Implementation Guide.
3. Promote the consistent use of the examples as displayed in the Implementation Guide for all government, carrier and system supplier inquiries and exchange of information. All examples shown in Appendix B of the Implementation Guide have been reviewed and agreed by the PNRGOV Working Group.
4. It is the responsibility of the State to ensure that data privacy laws, with regard to the data received through PNRGOV message, are addressed and that the data is protected.
5. It is the responsibility of the Carrier to ensure that data privacy laws, with regard to the data collected and transmitted through PNRGOV message, are addressed and that the data is protected.
6. The requirement for PNR data transfer should be governed by explicit legal provisions and should include departure, arrival and overfly where applicable.
 - The reason for requiring PNR data should be clearly explained by the laws or regulations of the State, or in explanatory material accompanying such laws or regulations, as appropriate. (ICAO's Doc 9944 Section 2.4 Laws or Regulations).
 - A Carrier is obliged to observe the laws of both the State from which it transports passengers (State of departure) and the State to which these passengers are transported (Destination State). Therefore, when a State legislates for its PNR data transfer requirements, it should recognize that existing laws of other States may affect a Carrier's ability to comply with these requirements. In addition where a carrier operates flights outside the borders of its own country, the laws of the home state must also be adhered to.
 - Where a conflict arises between any two States, or where a Carrier advises of a conflict, the parties involved should consult with each other to determine how affected Carriers can continue to operate within the law of both States. (See ICAO's Doc 9944 Section 2.4 Laws or Regulations)

The Carrier will provide to the State that PNR data which is available within the Carrier's system(s). This has been defined by ICAO as: "States should not require an operator to provide PNR data that are not already collected or held in the operator's reservation or departure control systems. The specific data elements that might be available from an aircraft operator's system will also depend on the type of air transport services provided by the operator." (See ICAO's Doc 9944 Section 2.4 Laws or Regulations), and by how and by whom the passengers' reservations were finalized.

7. The delivery schedules of the messages may vary according to each State. The delivery mechanism for the message may vary according to each State. Clarity regarding the sending, receiving, processing time periods is beneficial for all.
8. All data for the flights is sent in the initial message. Additionally, and in accordance with national requirements, the full PNR details including all changes to information previously transmitted is sent subsequently at the times specified by the States. Alternatively, and subject to national requirements and/or through bilateral agreement, only changes to the PNR(s) previously transmitted plus new PNR(s) may be sent at the specified times.
9. An acknowledgement message has been defined for States to be able to confirm to Carriers the receipt of the PNRGOV message. This enables automatic retransmission of messages not received / delivered. Where possible, it is in the best interests for this acknowledgement to be used to ensure messages are received and that the Carriers have fulfilled their obligations for the successful delivery. However, depending on the bilateral agreements in place between States and Carriers, it may not be applicable. See section 3.2.2 for further information.
10. The PNRGOV message does not replace any existing messages, but may result in reduction of other messages in the future.
11. It is responsibility of the Carrier to ensure timely generation and submission of the PNRGOV message in accordance with each State's legislation and /or regulations. States need to be aware it can take a variable amount of time for the Carriers or the intermediaries to construct a message within their system(s), transmit the message to the State and for States to receive the message. If the variability is a concern for the state, bilateral agreements between the State and Carrier may be needed to clarify the time period of receipt of data.
12. If retransmission of messages is applicable, details of the timings and the acknowledgement (ACK) message used to trigger this action can be found in section 3.2.2.
13. For split PNR data, the information provided is the record locator(s) of the split PNR(s) and the number of passengers split. No additional data is provided.
14. Emergency Lock procedures (i.e. process to control data release following an emergency or incident involving a particular flight) are based upon bilateral agreements between States and Carriers. System providers may be required to

- implement the capability to override data transmission restrictions put in place during an emergency lock.
15. While not currently mandated, the underlying principle guiding development of the PNRGOV message is to provide a standard message structure that may be utilized by States and Carriers.
 16. States retain the authority to request information via their existing PNR Pull mechanisms.
 17. To ensure consistency, it is recommended that States use the default service characters as defined in ISO9735 – 1 in the PNRGOV message structure. The UNA service segment shall be used if the service characters differ from the defaults.
 18. Level A Character set as defined in ISO 9735 standard is used for the EDIFACT PNRGOV messages.
 19. UTF-8 Character set as defined in defined in ISO 10646-1:2000 Annex D is used for the XML PNRGOV messages. For XML PNRGOV messages, Carriers should send data as stored in reservation or DCS systems. States should be able to accept any data received in UTF-8 encoding.
 20. Certification procedures and validation of data are defined through a bilateral agreement between the State and Carrier.
 21. Where messages are split for delivery due to application or protocol limitations, the data for any one PNR must not be split across transmitted blocks. A single transmission may contain multiple PNRs
 22. Carriers will not be required to transmit PNRs that are created solely for the purpose of blocking inventory (i.e. seats) and not intended to contain passenger information. It should be noted that carriers may not be able to prevent the transmission of these PNRs & these PNR's may not contain traveler information. States should be aware of the business impact on their systems of PNRs containing no passenger name data.
 23. States would want carriers/system providers at suitable opportunities (system upgrades) to migrate away from using LTS and move to the structured history segments (where possible) elements from the LTS that could be mapped into the appropriate structured elements provided in the PNRGOV message.'

3 FUNCTIONAL and BUSINESS REQUIREMENTS

3.1 Business Requirements

3.1.1 Multi-Leg Flights (multiple departure points using the same flight number)

Carriers & system providers support different models of pushing PNR to States on Multi-Leg (also known as Multi-Sector) flights where the same flight number is used:

Noting that, States may not be legally able to accept information for passengers not flying to/from/through their borders.

States should consider designing their systems in order to accept all of the strategies. Alternatively, bilateral agreements between States and Carriers maybe required.

3.1.1.1 Requirements for Multiple States

The following examples are intended to show, based on the PNRGOV requirements of the individual States, to whom the Carrier may be required to submit PNRGOV information for a Multi-Leg flight.

PNRGOV messages may be required to be sent for in transit passengers according to applicable legislation of the State. This is also relevant for both Inbound and Outbound passengers.

Example 1 – Flight routing: LHR – YYZ – JFK

States to whom PNRGOV message Data Sent, (see section 1.6)

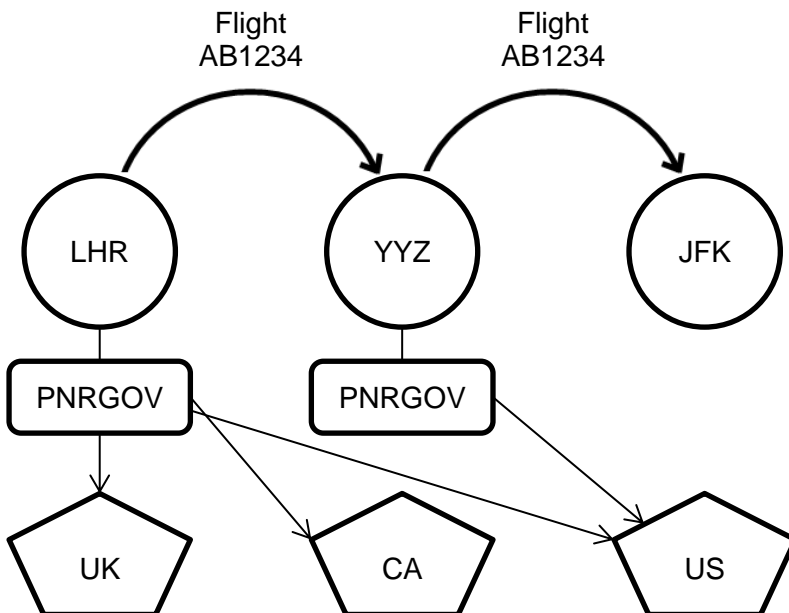

PNRGOV Transmission –

UK – PNRGOV Required for Departing and Arriving passengers

CA – PNRGOV Required for Arriving
US – PNRGOV Required for Departing and Arriving passengers

Example 2 – Flight routing: LHR –JFK – YYZ

States to whom PNRGOV message Data Sent, (see section 1.6)

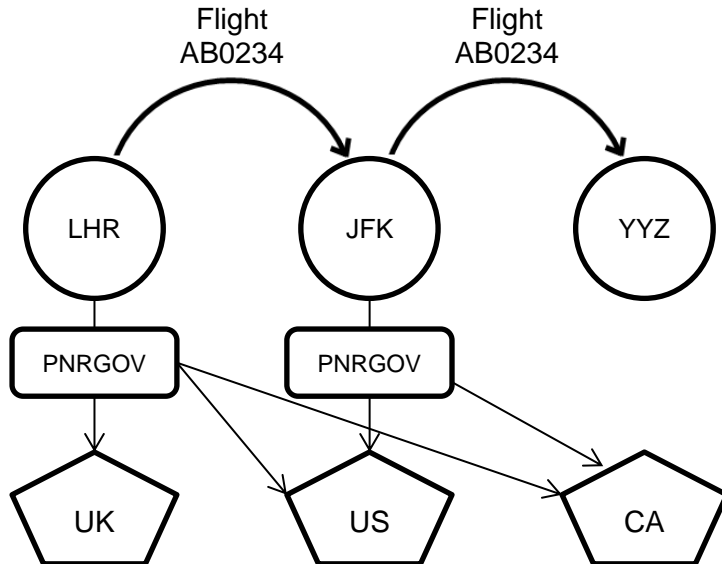

PNRGOV Transmission

UK – PNRGOV Required for Departing and Arriving passengers
US – PNRGOV Required for Departing and Arriving passengers
CA – PNRGOV Required for Arriving passengers

Additional information relating to PNRGOV submission and transmission can be found in section 3.2.1.

3.1.1.2 Multiple Sector PNRGOV Pushes to a Single State

The following examples are intended to show from which ports PNRGOV messages will be transmitted on a multi sector flight.

Example 1

Flight routing: DKR – TUN – MRS (where MRS is the port in the receiving State).

States should be aware of the following possible PNR Push models that may be in operation from Carriers & system providers:

- A PNR push (or set of pushes) containing all passengers, including those travelling DKR – MRS, on the TUN – MRS (transborder leg) only.

- A PNR push (or set of pushes) containing the passengers flying the DKR to MRS segment and a separate PNR push (or set of pushes) containing the passengers boarding at TUN flying to MRS. System limitations may prevent the Carrier from sending a complete set of pushes for the DKR – MRS segment.

Example 2

Flight routing: KWT – LHR – JFK (LHR is the transit port in the receiving State)

States should be aware that the itineraries of passengers travelling KWT – JFK may not include the port from LHR and therefore appear not to be reportable to LHR.

Example 3

Flight routing: DUB – SIN – SYD – WLG (where SYD is the port in the receiving State).

Where PNR pushes from both DUB and SIN are required to be sent to the State. System limitations may prevent the carrier from sending a push from DUB. Therefore States may need to be flexible in mandating the pushes from port DUB & SIN.

Noting that State AU requires PNR pushes for passengers travelling –

- DUB-SYD
- DUB- WLG
- SIN-SYD
- SIN- WLG
- SYD- WLG

Example 4,

Flight routing: LAX – EWR – CDG (where LAX & EWR are in the same country).

States need to be aware that carriers may only be able to provide pushes of data for the transborder legs. That is, where EWR – CDG is the transborder leg, passengers travelling LAX – CDG will be reported in the EWR – CDG pushes, their individual itineraries may state LAX – CDG.

Example 5, Round Trip / Circular flights

Flight routing: DEL – JNB – DEL (where JNB is the port in the receiving State).

The flight number is the same on both the arrival and departure.

3.1.2 Multiple State Requirements

In order to minimize the scale of development on both the Carrier(s) and State(s), the PNRGOV message defines all of the requirements as agreed through the PNRGOV working group. The governing principle is that all States should utilize the defined standard message to ensure greater interoperability.

3.1.3 Multiple System Interaction

Although the PNRGOV message is a standard message as adopted by the PADIS Board, the method of message delivery may vary according to the State receiving it and the carrier or provider sending it.

3.1.4 Overflights

Individual States may require information for flights overflying their territory to be sent to them in the PNRGOV format. This is anticipated to be catered for by each Carrier in their establishment of the rules for the data submission on a State by State basis.

3.1.5 Operating Carrier v Marketing Identification and Message Structure

The structure and the information contained in the PNRGOV is based on the Operating Carrier and the system(s) it uses to support the storage of flight data. The message structure is designed to also accommodate information relating to the Marketing Carrier.

3.1.6 Message Sizing

The size of the message is governed by the transport protocol or application used by the States and Carriers according to their system capabilities. If the message must be split into smaller component parts, this functionality may occur at the application or protocol layer; however, in no case should an individual PNR be split between messages. Depending on the solution to the splitting of the message, each Carrier / State is responsible for ensuring that the method adopted adheres to the individual audit requirements.

3.1.7 PCI – DSS Compliance

Due to the requirements of the Payment Card Industry Data Security Standard (PCI–DSS) for securing credit card numbers and other associated sensitive data, when that data is stored within the Carrier’s system that storage must be in accordance with their own PCI-DSS compliancy policy. Where the information is to be submitted to the States in line with relevant legislation and applicable PNRGOV requirements, the Carrier must adopt one of the following minimum standards for security relating to the data transmission:

- Secure Socket Layer (SSL) v3
- Transport Layer Security (TLS) v1.0
- Secure File Transfer protocol (SFTP) using SSH Secure Shell (SSH-2)
- IPSec over IPv4 /Ipv6
- Other requirements as advised by PCI Security Standards Council.

3.1.8 PNR Data Elements

The data elements that are required by the States are managed through a bilateral arrangement between the States and Carriers as defined by national legislation. In an effort to standardize the PNRGOV message structure, the following table identifies the current position of the 18 items as required by States with the 19th Item being the historical

data of the previously identified 18 items. The governing principle is that all States should utilize the defined standard message to ensure greater interoperability. Information around these 19 items is defined in ICAO Document 9944 “Guidelines for Passenger Name Record (PNR) Data” to which ICAO Annex 9 Recommended Practice 3.47 refers.

If a Carrier maintains cancelled PNR’s within its reservation system States may expect to receive those records – even if stored only as historical records within that system. If Carriers do not maintain these types of PNR records, then States would not receive them.

19 PNR Data Elements
PNR record locator code
Date of reservation / issue of ticket
Date(s) of intended travel
Name(s) on the PNR
Available frequent-flyer information (free tickets, upgrades, etc)
Other names on PNR, including numbers of travelers on the PNR
All available contact information (including originator information)
All forms of payment information and billing information (not including other transactions details linked to a credit card or account and not connected to the travel transaction)
Travel itinerary for specific PNR
Travel agency and Travel agent
Code share PNR information
Split / Divided PNR information
Travel status of passenger (including confirmations and check-in status)
Ticketing information including Ticket number, one way tickets, and Automated Ticket fare quotes
All baggage information
Seat information include seat number
General remarks including OSI and SSR information
Any collected APIS information
All historical changes to the PNR listed in data types 1 to 18 above

3.1.9 Context

Due to the nature of the information contained within individual PNRs and the rules pertaining to the provision of data, the PNRGOV data may need to be sent to multiple States. The timing of those individual transmissions may vary, and are dependent on the specific requirements of individual States.

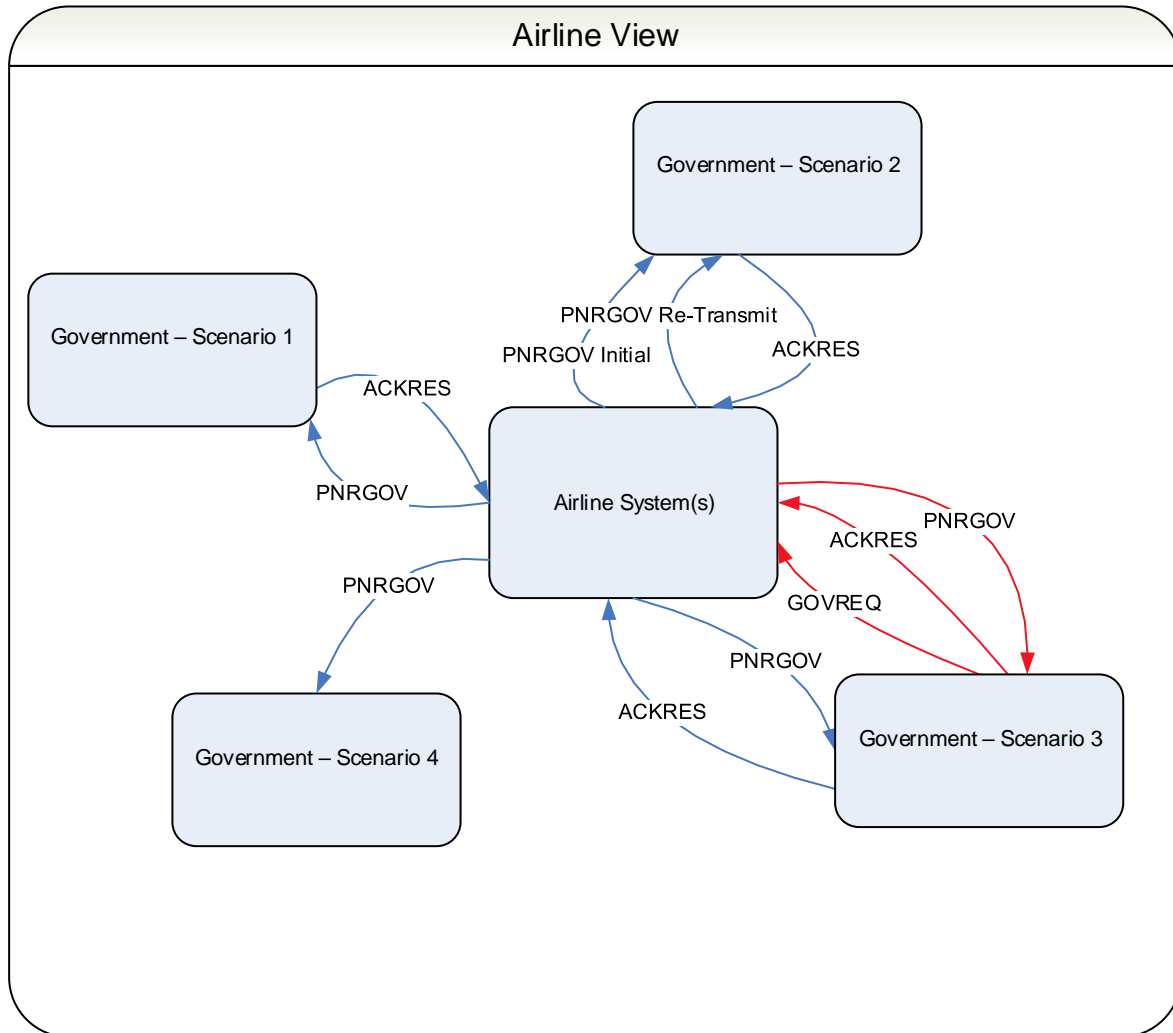

Exhibit 2 - Generic Context Diagram (airline perspective)

- Government - Scenario 1: Airline system sends PNRGOV and Government system returns ACKRES.
- Government - Scenario 2: Airline system sends PNRGOV and Government system does not return ACKRES. Airline system re-sends PNRGOV and government returns ACKRES.
- Government - Scenario 3: Airline system sends PNRGOV, Government returns ACKRES. Government also sends ad hoc GOVREQ, Airline system sends PNRGOV and Government returns ACKRES.
- Government - Scenario 4: Airline system sends PNRGOV and Government does not return ACKRES.

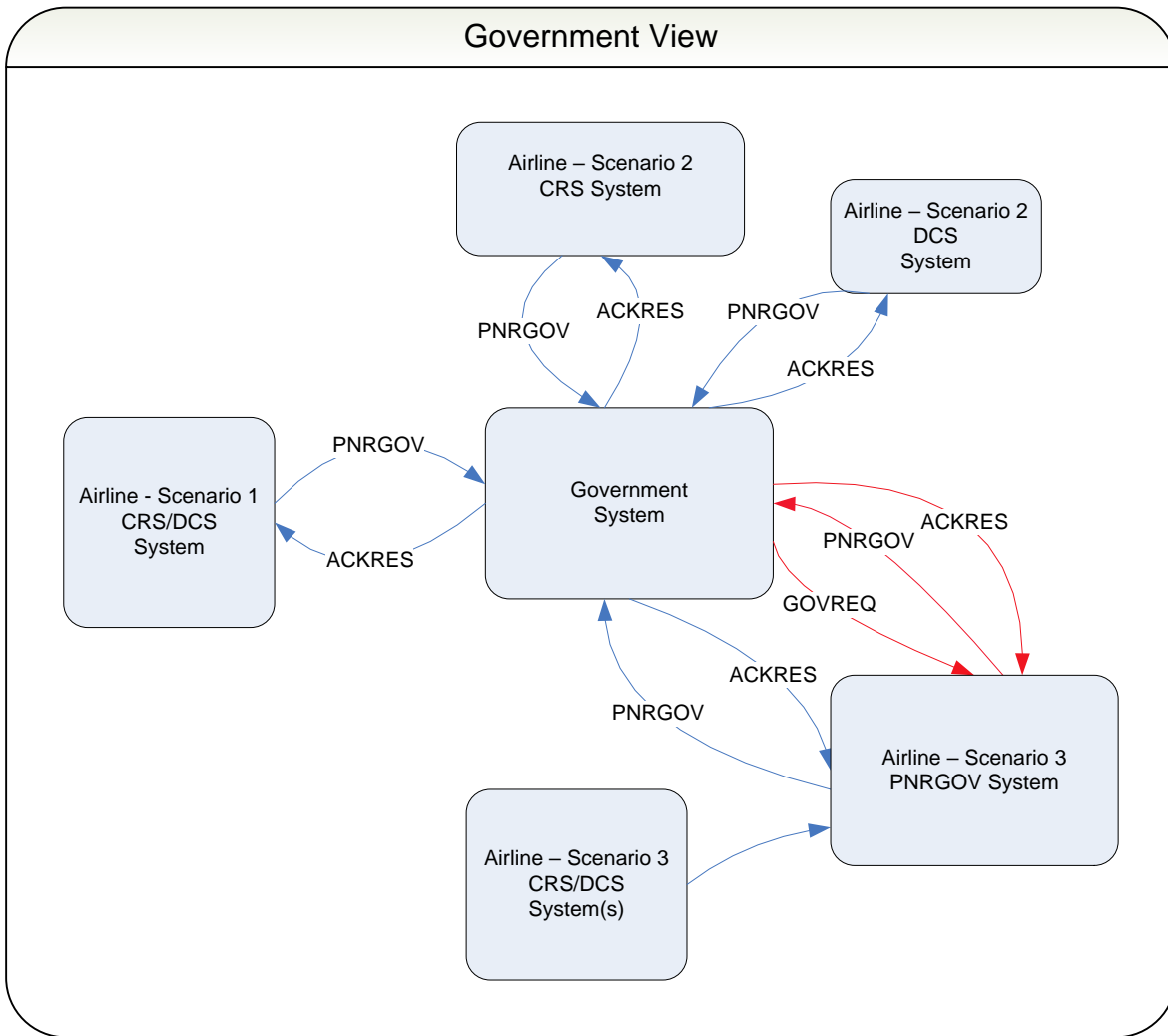

Exhibit 3 - Generic Context Diagram (government perspective)

CRS = Computer Reservation System (sometimes referred to as Global Distribution System)

DCS = Departure Control System

Airline - Scenario 1: Airline sends PNRGOV from a combined CRS and DCS system and Government returns ACKRES.

Airline - Scenario 2: Airline sends PNRGOV from separate CRS and DCS systems and Government returns ACKRES.

Airline - Scenario 3: Airline sends PNRGOV from an outside system with a process that gathers data from the CRS/DCS, sends PNRGOV and Government returns ACKRES. Government also sends ad hoc GOVREQ, Airline system sends PNRGOV and Government returns ACKRES.

3.2 Functional Requirements

3.2.1 Data submission

The following table is designed to show examples of the possible requirements by States for the delivery of the data.

State Bodies	No of Messages	Timing	Inbound / Outbound
AAA	1	Wheels Up	Inbound
BBB	2	1) -24hrs 2) Wheels Up	Inbound / Outbound
CCC	4	1) -72hrs, 2) -24hrs 3)-8hrs 4) Wheels up	Inbound / Outbound
DDD	5	1) -72hrs, 2) -24hrs, 3) -2hrs 4) -1hrs 5) Wheels Up	Inbound / Outbound

3.2.2 Message Acknowledgement and Retransmission

In order for the Carriers to be able to comply with, and ensure the delivery of PNRGOV messages to the States, the optimal method is for States to provide an acknowledgement of receipt back to the Carrier. This is an acknowledgement that the State has received the message. The acknowledgement in no way implies that the data has been processed. If the Carrier does not receive a message acknowledging receipt, this will facilitate the retransmission of the message to the relevant State.

3.2.2.1 EDIFACT

An acknowledgement message (ACKRES) has been defined to enable additional information to be provided to the Carriers; such as content errors identified while processing the data. The ACKRES message may be agreed and implemented through a bilateral agreement between individual States and Carriers.

UN CONTRL messages can be used to report EDIFACT syntax errors. This is based on a bilateral agreement between States and Carriers.

3.2.2.2 XML

An acknowledgement message (IATA_AcknowledgmentRS) has been defined to enable additional information to be provided to the Carriers. The XML message allows for returning either a Warning element or an Error element.

The Warning element is used along with the Success element to indicate that the message was received. If only the Success element is returned, then either no errors were found or it may only be an acknowledgement that the request was received. If the Warning element is also returned, then a business error was found. In the Warning element, a PADIS error code will be returned and the x-Path of where in the request the error occurred may also be returned in the

Tag attribute. In order to further narrow the location of the error, the RecordID could be used to return the BookingRefID/ID of the PNR where the error was encountered. The Error element may be returned when the recipient is unable to process the message, i.e., the message version is not supported or the recipient does not accept the request being sent. The use of the Error element is similar to the use of the EDIFACT CONTRL message.

Message acknowledgement table

	EDIFACT	XML
Successful receipt & processing	ACKRES	IATA_AcknowledgementRS
Successful receipt & functional data errors	ACKRES	IATA_AcknowledgementRS
Non-application errors	CONTRL	IATA_AcknowledgementRS

3.2.3 Provision of an Ad-hoc request using the GOVREQ message

The State may require an ad-hoc transmission of PNRGOV data, subject to a bilateral agreement between the State and the carrier. The ad-hoc request may be for a specific flight/date or for a specific record locator. This message is to be used only in exceptional situations.

3.2.4 Separate Operational Systems – DCS without full PNR access

A Carrier may have a local DCS or agreements in place with one or more systems to handle their operations at certain stations. It should also be noted that multiple systems may handle the flight throughout its itinerary, e.g., with a flight routing AAA – BBB – CCC – DDD where,

Company one handles the flight out of city AAA,

Company two handles the flight out of BBB, and

The actual operating Carrier handles the flight out of CCC to DDD.

The handling systems may not have all of the information which is contained in the original PNR. Instead, they may have only sufficient data needed to identify the passenger and any particular special conditions for the purpose of check-in. In such circumstances, the State and Carrier may bilaterally agree on the information available for inclusion in the PNRGOV message.

A Carrier and State may also bilaterally agree to exchange the PNRGOV message with only that data which is currently available within the DCS system used by the operating Carrier or its contracted handling agent to support the flight/station for which the PNR data is required.

3.2.5 Management of outages

Operation of all systems may be subject to outages. Carriers and States would be expected to set up bilateral agreements to manage such outages.

3.2.6 Manual DCS operations

There may be times or locations where the check in process is handled in a manual operation, e.g. system outages, small stations, etc. In this case there is no information available to be sent to the States at the stipulated transmission times.

3.2.7 Irregular operations

In cases of flights subject to circumstances affecting its original schedule, the following rules may apply.

For cancelled flights, it may not be possible to transmit data for any or all scheduled pushes.

If the reservation system is synchronised with DCS, the data may be transmitted at the time the delayed or renumbered flight departs.

3.2.8 Reservation & Departure Control system integration

The PNRGOV message is built from Reservation data & any available departure control system, passenger check in data.

There are a number of technical constraints that can affect the inclusion of Check In data into the PNRGOV message. Where a carrier uses differently hosted reservation system and a departure control system providers then there a number of technical issues that are required to be understood:

- The Reservation system, RCI - Reservation Control Number & the Departure Control System, RFF+AVF -Reservation Reference Number, may be different numbers.
- The Reservation system, REF- Unique Passenger Reference Identifier & the Departure Control System, RFF+ABO - Unique Passenger Reference Identifier, may be different numbers.
- The technical means of supplying back to the originating reservation system the check in information, which may result in message transmission delays.
- States message timings requirements
- DCS Check in Data may not be present in PNRGOV pushes until Flight Close

Noting that the RCI - Reservation Control Number may also be known as:

- Record Locator
- PNR locator
- RLOC
- RECLOC
- RL

The final push of PNRGOV data for a flight is at the time at which no further passengers may board the aircraft, and is typically triggered by one the following events:

- Doors closed
- Push Back of the aircraft
- Wheels up of the aircraft

The following diagrams are provided to show some of the different models in operation, where:

- PNL= Passenger Name List
- ADL=Additions & Deletions List
- PRL= Passenger Reconciliation List
- RL= Record Locator (see above)
- UPRI= Unique Passenger Reference Identifier
- FC = Flight Close/Flight Final

3.2.8.1 Same hosts for DCS and Reservation utilizing a “single database” example

With this model:

- Check in data will be included in a flight close PNRGOV message
- The Record Locator will match.

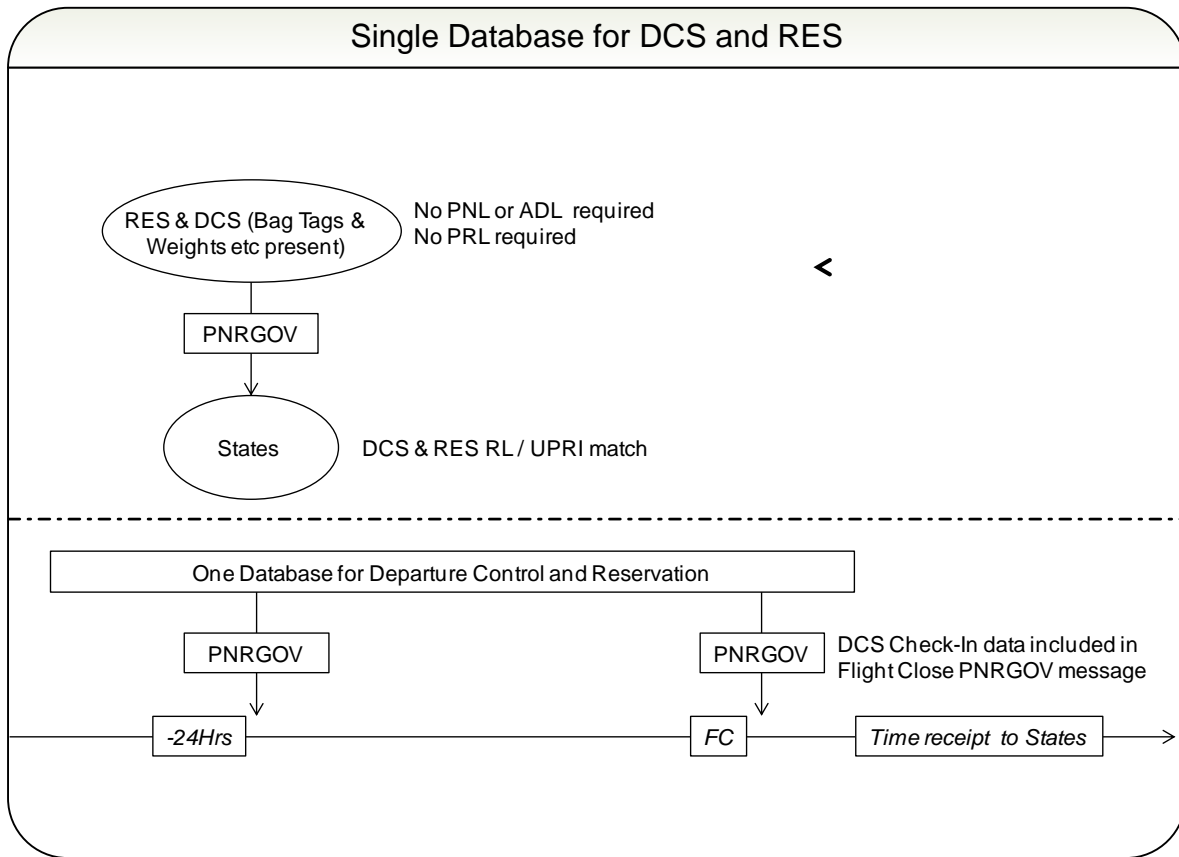

3.2.8.2 Same host for DCS and Reservation

With this model:

- Check in data will be included in a flight close PNRGOV message
- The Record Locator will match.

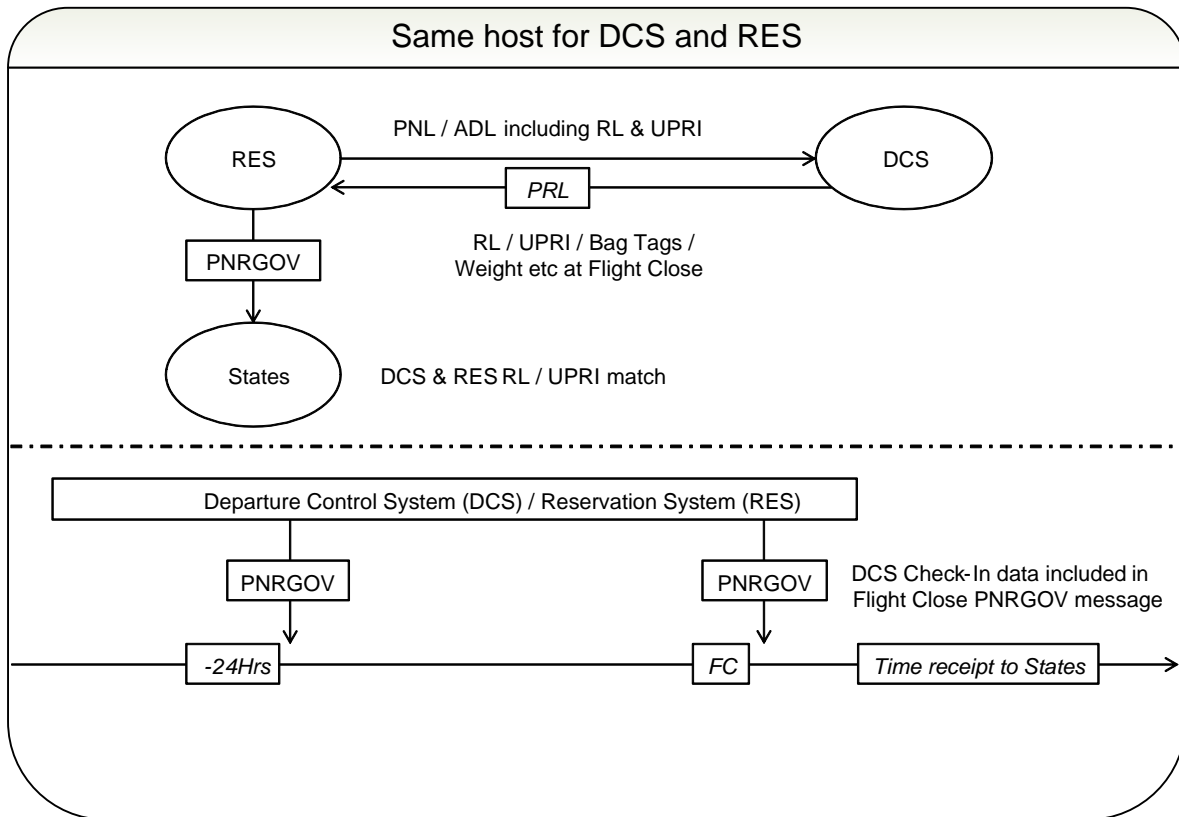

3.2.8.3 Different hosts for DCS and RES example

With this model:

- It is unlikely that check in data will be included in a PNRGOV flight close message.
- The Record Locator is unlikely to match.

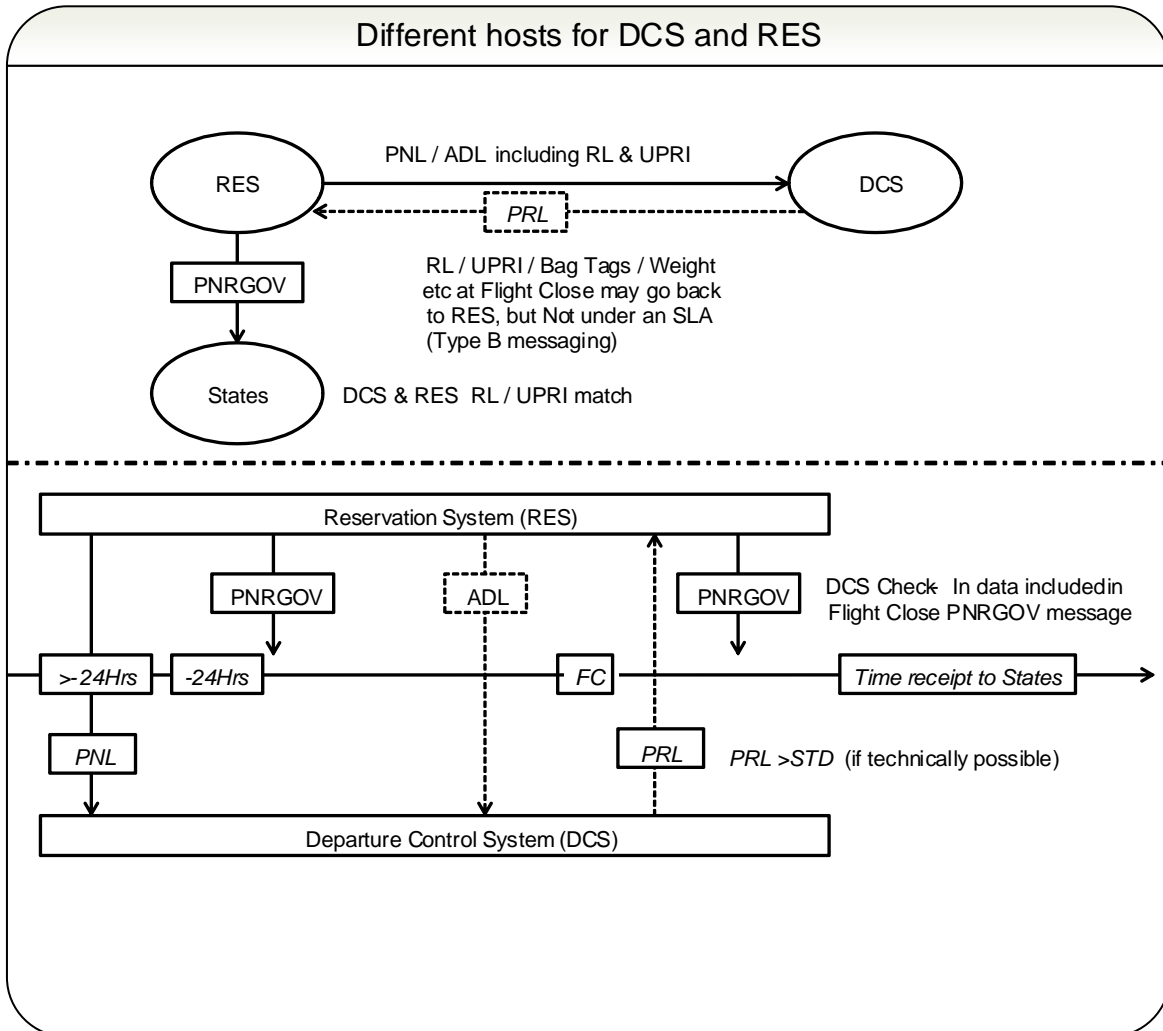

3.2.8.4 Travel Agent and Tour Operator

For example with charter flights:

- The PNRGOV content will be “limited” in content
- Items such as payment and contact details are may be missing in PNRGOV messaging.

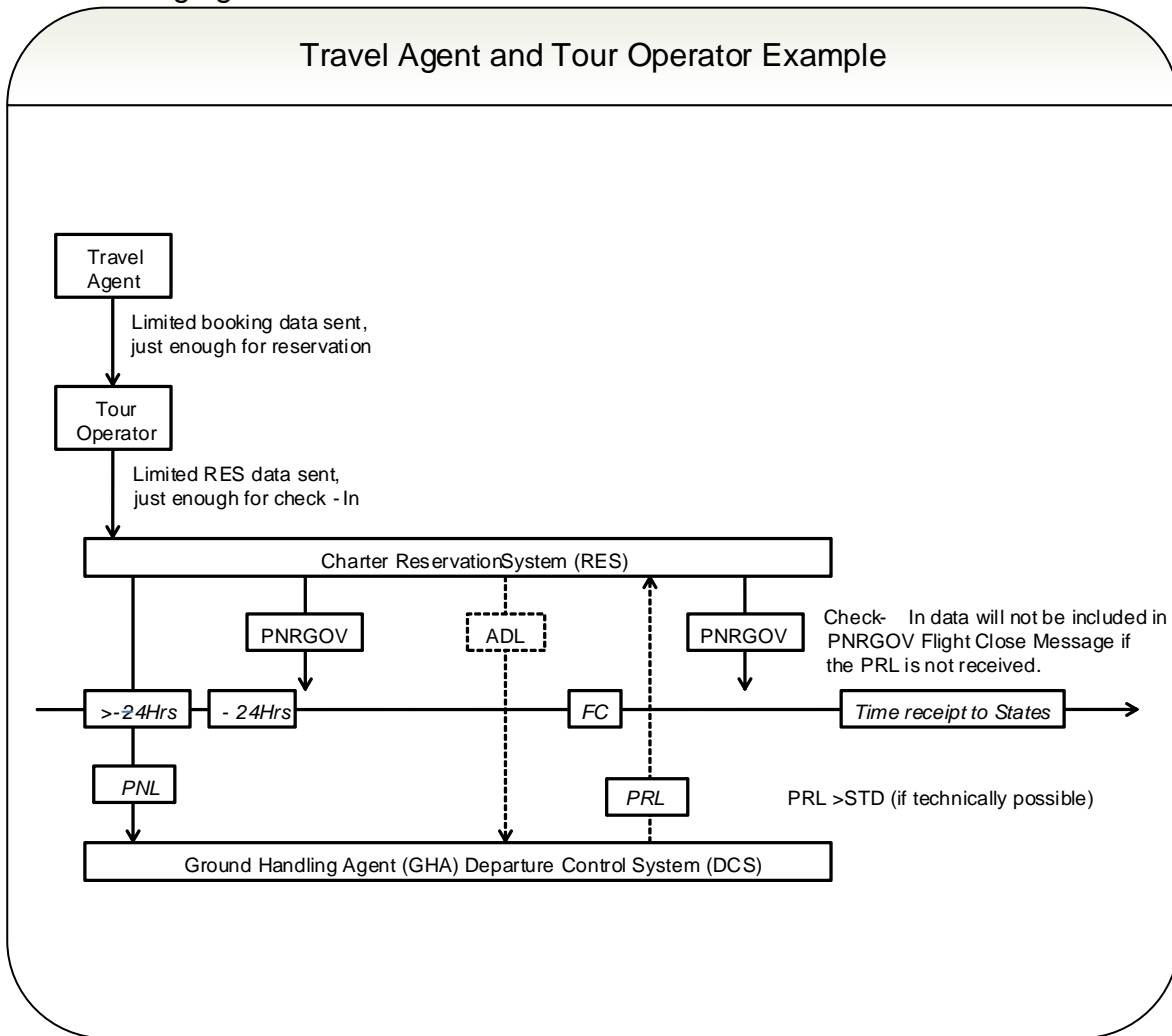

3.2.9 Infant Data in the PNRGOV message.

Infant: also call Lap Infant or Lap child. The amount of data that an airline system has on infants will vary by the airline system. Historically airline reservation systems were designed as inventory control systems, with the inventory being seats and infants do not occupy a seat. Infants are held on the lap of the adult that they are traveling with, and due to this history airline systems may not be able to maintain the same data for infants that they do for seated adults.

In the PNRGOV message, depending on the airline system an infant may or may not have a TIF item. Depending on the airline system, a TIF item may only be able to be sent for a seated passenger and the infant will be an SSR item for the passenger that is holding the infant.

Airline systems and policies vary. Below are some examples.

Infants may or may not have seats assigned to them. Infants that do not have seats assigned to them are held on the lap of the passenger that they are associated to. Passengers with infants are restricted on what seats they can occupy – this will vary by airline policy, equipment (aircraft) type and government regulations. Some examples – not a complete list.

- Infants are not allowed in exit rows.
- Only 1 infant per seat group due to available (extra) oxygen mask count.
 - Passengers with infants are only seated in a seat group with an extra oxygen mask.
- Some airline policies restrict infants in some (premium) cabins.

Passengers with infants may have a larger baggage allowance due to the infant (this will vary by airline). This is due to the way that airlines pass data items between airlines. All data associated with a passenger is passed associated to a seated passenger, including the infant.

Special note on TVL segments. In most traditional systems, all passengers in a PNR will have the same TVL segments. The exception to this are infants, Infants can travel more or less than the adults in the PNR (depending on the airline system).

- An example of an infant traveling less than the seated passenger is an adoption. In this case the infant is only on the return trip.
- Another example is when an infant is born while the parent is travelling and the infant now has a nationality that is different than the parent. The infant may need a “return trip” ticket when the parent returns home with the infant until the infant’s nationality is established with the parent’s homeland. The infant may be traveling more segments than the seated passengers.

Infants (child under 2 years old) with a seat should be treated like a “child” or any other seated passenger.

4 Modes of transmission

Each airline will have to specify the identity of the service provider that it uses, if any. It will also present the technical protocol used for transmitting the data.

Recognizing the different constraints of the aviation environment, the State system should take into account a range of connection formats.

States should consider confidentiality, integrity and non-repudiation for securing the message exchange.

5 APPENDIX A - GLOSSARY

Please refer to IATA Passenger Services Glossary of Terms located on IATA Web site:
<http://www.iata.org/whatwedo/passenger/Documents/passenger-glossary-of-terms.xls>.