



**World Customs
Organization**

Guide for Technical Update of Preferential Rules of Origin

Origin sub- directorate
Tariff and Trade Affairs Directorate
World Customs Organization

ori@wcoomd.org

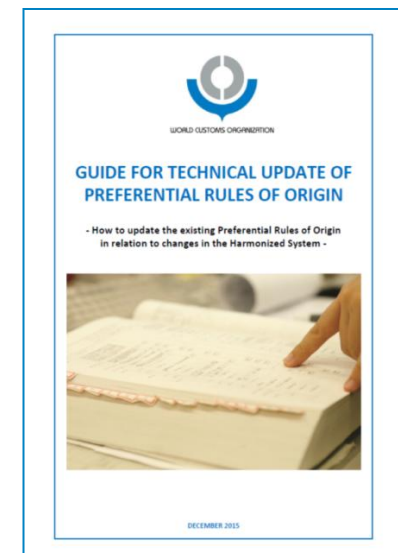

Table of Content



1. Introduction

2. Relationship to the HS

3. Necessity to consider if there is a need for a technical update

4. WCO Guide for the Technical Update of Preferential Rules of Origin

5. Method for the Technical Update

6. Summary

What are Preferential Rules of Origin?

A set of rules which define the conditions under which preferential tariff treatment is granted to products traded under preferential trade arrangements (e.g., FTAs).



Under an FTA, ONLY the “originating goods” qualify for preferential tariff treatment

Concept of “Originating Goods”

Goods are deemed to originate in a preferential area when they are:

- wholly obtained in the preferential area; or
- substantially transformed in the preferential area

Product specific rules (PSRs)

- **Change in tariff classification (CTC) rules**
- Value added rules
- Specific manufacturing or processing operation rules

Table of Content



1. Introduction

2. Relationship to the HS

3. Necessity to consider if there is a need for a technical update

4. WCO Guide for the Technical Update of Preferential Rules of Origin

5. Method for the Technical Update

6. Summary

Product Specific Rules (PSRs)

Product specific rules of origin are listed according to the HS.



Product Specific Rules	
HS code	Origin criteria
0101.21	Change of Chapter
0101.29	Change of Heading
0101.30	Value Added Rule (XX %)
⋮	⋮

Correct classification of goods is a requisite for determining the applicable origin criterion.



Wrong classification leads to **wrong origin determination...**

Change in Tariff Classification (CTC) Rules

Common type of rules. The final product must be classified in a Chapter, heading or subheading (depending on the exact rule) different from all non-originating materials used.

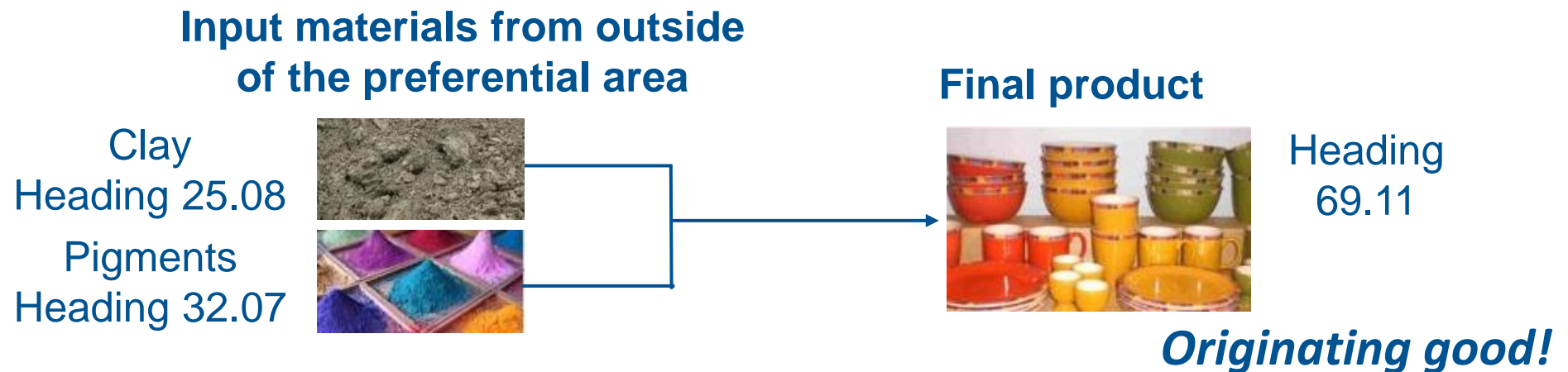

Correct classification of both the final product and input materials is necessary for origin determination

WCO STUDY ON THE USE OF “CTC-BASED RULES”

Findings

◆ Proportion of “CTC-based rules”

In the 20 largest FTAs selected according to trade volume, the average proportion is **73.41%**. Moreover, it **exceeds 95%** in more than half of them.



HS classification is an extremely important factor in origin determination

Table of Content



1. Introduction

2. Relationship to the HS

3. Necessity to consider if there is a need for a technical update

4. WCO Guide for the Technical Update of Preferential Rules of Origin

5. Method for the Technical Update

6. Summary

HS is normally updated **every 5 years** (2002, 2007, 2012, 2017, 2022 ...)

If different editions of the HS are used for purposes of HS classification and origin determination, respectively...



Determination of the origin becomes
complicated and time-consuming

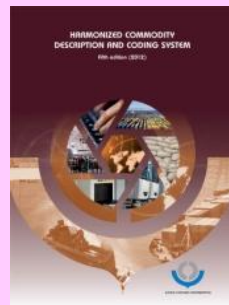

Classification
(HS 2022)
Latest edition



Rules of Origin of FTAs
(HS2017, HS 2012, HS 2007, etc.)
Older edition

Example : Light-emitting diode (LED) modules

Classification : HS 2022; Rules of Origin of FTA: HS 2017

HS 2017		HS 2022	
85.39	Electric filament or discharge lamps, including sealed beam lamp units and ultra-violet or infra-red lamps; arc-lamps.; light-emitting diode (LED) lamps.	85.39	Electric filament or discharge lamps, including sealed beam lamp units and ultra-violet or infra-red lamps; arc-lamps; light-emitting diode (LED) light sources.
8539.10	- Sealed beam lamp units	8539.10	- Sealed beam lamp units
...
	- Ultra-violet or infra-red lamps; arc-lamps		- Ultra-violet or infra-red lamps; arc-lamps :
8539.41	-- Arc-lamps	8539.41	-- Arc-lamps
8539.49	-- Other	8539.49	-- Other
85.43	Electrical machines and apparatus, having individual functions, not specified or included elsewhere in this Chapter.		- Light-emitting diode (LED) light sources :
<u>8543.70 - Other machines and apparatus</u>		8539.51	-- Light-emitting diode (LED) modules
	etc.	8539.52	-- Light-emitting diode (LED) lamps
		8539.90	- Parts



Classifying goods in the older HS requires **additional time.**



+

Risk of misclassification

Example : Ginger of heading 09.10

Classification : HS 2022; Rules of Origin of FTA: HS 2007



HS 2007		HS 2012 (until now)	
0910.10	- Ginger 	0910.11 0910.12	- Ginger : -- Neither crushed nor ground -- Crushed or ground 



Does the **origin criterion (i.e. CTSH)** for subheading 0910.10 (HS 2007) continue to apply to subheadings 0910.11 and 0910.12 (HS 2022) ?

HS 2007		HS 2012 (until now)	
0910.10	CTSH (Change in Tariff Subheading)	0910.11 0910.12	CTSH No



Risk of misapplication of Rules of Origin

NECESSITY TO CONSIDER IF THERE IS A NEED FOR A TECHNICAL UPDATE



Example : Ginger of heading 09.10



Classification : HS 2022; Rules of Origin of FTA: HS 2007

HS 2007		HS 2012 (until now)	
0910.10	- Ginger 	0910.11 0910.12	- Ginger : -- Neither crushed nor ground -- Crushed or ground

Imported material



0910.10
(HS 2007)

Grinding →

Final product



0910.10
(HS 2007)

Grinding does not confer origin!

Since both ground and non-ground ginger are classified in the same subheading in HS 2007, grinding of ginger does not involve any change in tariff classification.

NECESSITY TO CONSIDER IF THERE IS A NEED FOR A TECHNICAL UPDATE



Example : Ginger of heading 09.10



Classification : HS 2022; Rules of Origin of FTA: HS 2007

What origin criteria will be applied in the HS 2022?

HS 2007 (Original criterion)		HS 2012 (until now) (Technically updated criteria)	
0910.10	CTSH (Change in Tariff Subheading)	0910.11 0910.12	CTSH except from 0910.12 CTSH except from 0910.11



- ✓ Adjustments may be required to maintain the original criterion (HS 2007).
- ✓ Impossible change may be disregarded.





NECESSITY TO CONSIDER IF THERE IS A NEED FOR A TECHNICAL UPDATE



Example : Ginger of heading 09.10



Classification : HS 2022; Rules of Origin of FTA: HS 2007

HS 2007 (Original criterion)		HS 2012 (until now) (Technically updated criteria)	
0910.10 	CTSH (Change in Tariff Subheading)	0910.11 CTSH	CTSH
		0910.12	CTSH excluding from 0910.11 

We may need more examination for 0910.12!



Technical update can serve to identify commodities with a higher risk of misapplication of rules of origin in an efficient manner.

Consistency in the structure of the HS and Rules of Origin would :

- Prevent misapplication of Rules of Origin
- Facilitate origin determination
- Allow Customs to enhance their risk assessment and management of origin



Ensure efficient and effective revenue collection



Table of Content



1. Introduction

2. Relationship to the HS

3. Necessity to consider if there is a need for a technical update

4. WCO Guide for the Technical Update of Preferential Rules of Origin

5. Method for the Technical Update

6. Summary

WCO Guide for Technical Update of Preferential Rules of Origin



- **Objectives:** Assist Members in the technical update of their existing Rules of Origin

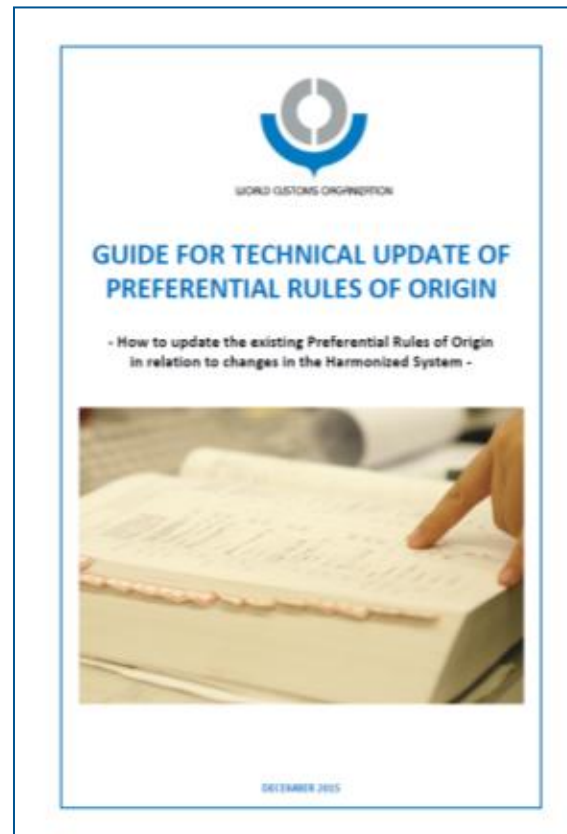

- The Guide provides practical information on **how to conduct a technical update of Rules of Origin** in relation to changes in the HS

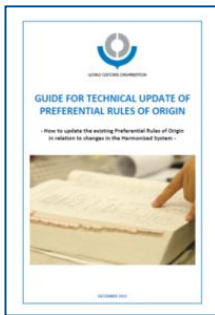

Table of Contents

1. Introduction
2. Objectives
3. Necessity to consider if there is a need for a technical update
4. Method for the technical update
5. Procedure manual (including actual examples)
6. Possibility for simplification of Rules of Origin

Annexes

- Annex I : Table correlating HS 2002-HS 2007
- Annex II : Table correlating HS 2007-HS 2012
- Annex III : Table correlating HS 2012-HS 2017
- Annex IV : Table correlating HS 2017-HS 2022



Annexes to the Guide

Annex III : Table correlating HS 2017-HS 2022

HS 2017 Version	HS 2022 Version	Necessity to consider if there is a need for a technical update:			Type
		CC	CTH	Other	
0208.90	0208.90	Yes	Yes	Yes	Table 1-1
0210.99	0210.99	Yes	Yes	Yes	Table 1-1
0403.10	0403.20	Yes	Yes	Yes	Other
0410.00	0410.10	Yes	Yes	Yes	Other
	0410.90	Yes	Yes	Yes	Table 1-2
1601.00	1601.00	Yes	Yes	Yes	Other
1602.10	1602.10	Yes	Yes	Yes	Other
1602.90	1602.90	Yes	Yes	Yes	Other
1704.90	1704.90	Yes	Yes	Yes	Table 1-2

- **Correlations between HS 2017 – HS 2022**
- **Necessity to consider if there is a need for a technical update**
- **Method of technical update**

- In the framework of the revision of Rules of Origin laid out in an FTA, this Guide will enable **time to be saved, and avoid problems** in amending such rules.

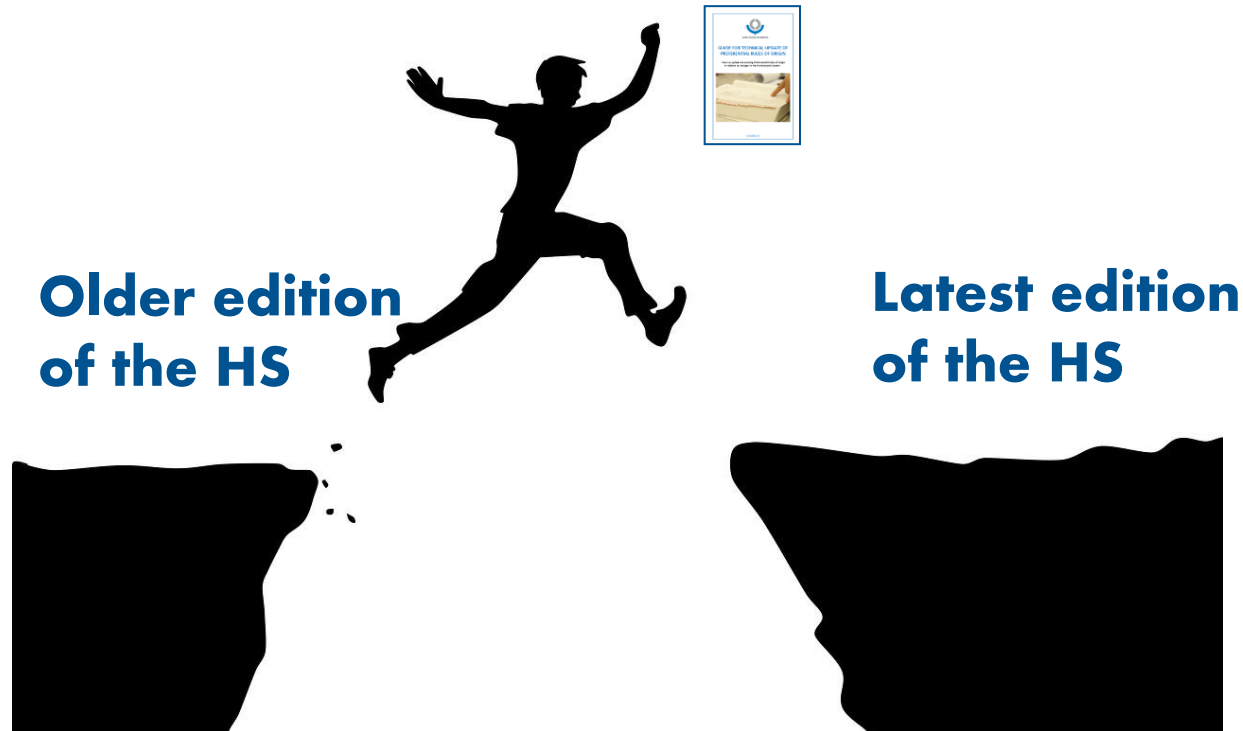
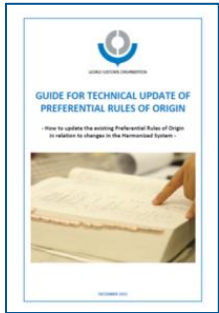



WCO GUIDE FOR THE TECHNICAL UPDATE OF PREF. ROO



- May also be used as **training material** to explain the mechanism for updating the Rules of Origin
- It is recommended that technical update be carried out **at the same time as preparations for implementation of the new edition of the HS**, preferably **with assistance from officials responsible for the HS**





WCO GUIDE FOR THE TECHNICAL UPDATE OF PREF. ROO



- Endorsed by the Council (June 2022)
- Published on the WCO Website:
World Customs Organization > Topics > Origin > Instruments and Tools
URL: <http://www.wcoomd.org/en/topics/origin/instrument-and-tools.aspx>
- Non-binding
- Living document – further development

Table of Content



1. Introduction

2. Relationship to the HS

3. Necessity to consider if there is a need for a technical update

4. WCO Guide for the Technical Update of Preferential Rules of Origin

5. Method for the Technical Update

6. Summary

Method for the Technical Update

Basic Methods

- 1) **Division of subheadings** : transfer of goods from one subheading to two or more subheadings
- 2) **Merging of subheadings** : transfer of goods from two or more subheadings to one common subheading

There are only two basic methods!



Method for the Technical Update *(cont.)*

Other Methods

- 1) Expansion of the scope of subheadings
- 2) Creation of subheadings in addition to the expansion of the scope of subheadings
- 3) Deletion and merging of subheadings
- 4) Renumbering of subheadings

 ***Technical update can be done by combining the basic methods !***



Basic Method

1) Division of subheadings

Origin Criterion (original)	Category of good	HS code (older edition)		HS code (later edition)	Category of good	Origin Criteria (technically updated)
CTC ₁	A ₁ , A ₂	X ₁		→ Y ₁	A ₁	CTC ₁ <u>except from A₂</u>
				→ Y ₂	A ₂	CTC ₁ <u>except from A₁</u>



- In order to maintain the original requirements, exclusions from A₂ and A₁ need to be added in the updated origin criteria for new subheadings Y₁ and Y₂, respectively.
- However, where the extent of transposition caused by an HS amendment is less than that of the changes required by the original origin criteria, the exclusions are not necessary.

Example 1: CTSH (Change in Tariff Subheading) criterion

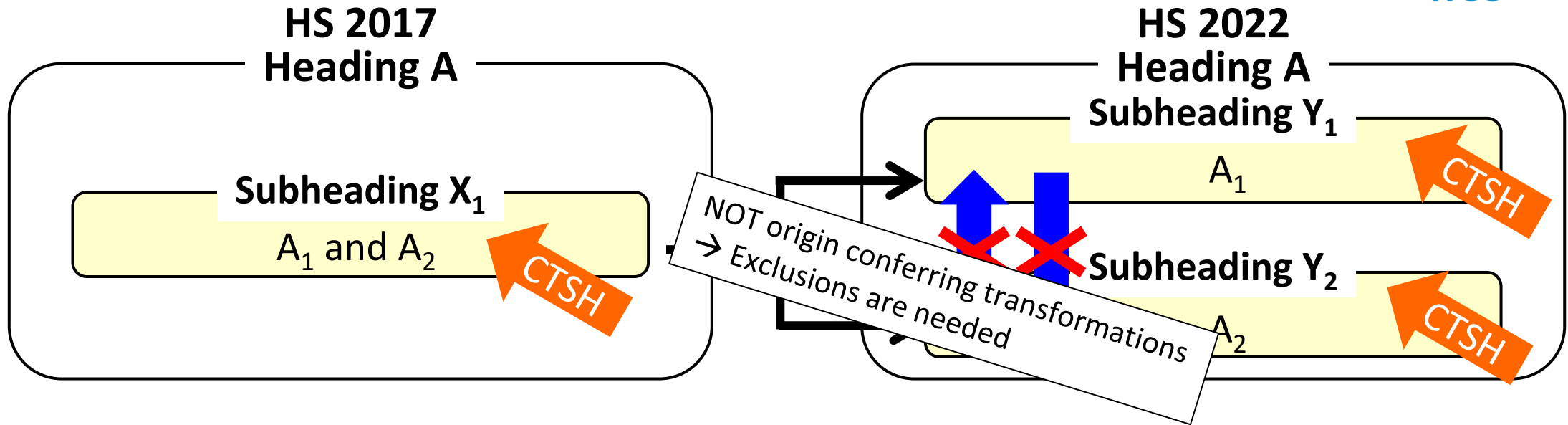

Since both goods of categories A_1 and A_2 belonged to subheading X_1 , manufacture from A_2 to A_1 and manufacture from A_1 to A_2 are not considered as origin conferring transformations. Therefore, exclusions from A_2 and A_1 need to be added to the origin criteria for new subheadings Y_1 and Y_2 , respectively.

Origin Criterion (original)	Category of good	HS code (older edition)	HS code (later edition)	Category of good	Origin Criteria (technically updated)
CTSH	A_1, A_2	X_1	Y_1	A_1	CTSH <u>except from A_2</u>
			Y_2	A_2	CTSH <u>except from A_1</u>

METHOD FOR THE TECHNICAL UPDATE



Example: Creation of new subheading 2204.22 (Wine (bag-in-box))

HS 2012		HS 2017	
22.04	Wine of fresh grapes, including fortified wines; grape must other than that of heading 20.09.	22.04	Wine of fresh grapes, including fortified wines; grape must other than that of heading 20.09.
2204.10	- Sparkling wine	2204.10	- Sparkling wine
2204.21	- Other wine; grape must with fermentation prevented or arrested by the addition of alcohol : -- In containers holding 2 l or less	2204.21	- Other wine; grape must with fermentation prevented or arrested by the addition of alcohol : -- In containers holding 2 l or less
2204.29	-- Other	2204.22	-- In containers holding more than 2 l but not more than 10 l
2204.30	- Other grape must	2204.29	-- Other
		2204.30	- Other grape must



How to technically update the origin criterion ?

HS 2012		HS 2017	
HS code	Origin Criterion (original)	HS code	Origin Criteria (technically updated)
2204.29	CTSH (Change in Tariff Subheading)	2204.22	CTSH <u>except from subheading 2204.29</u>
		2204.29	CTSH <u>except from subheading 2204.22</u>

METHOD FOR THE TECHNICAL UPDATE



Example 2: CTH (Change in Tariff Heading) criterion

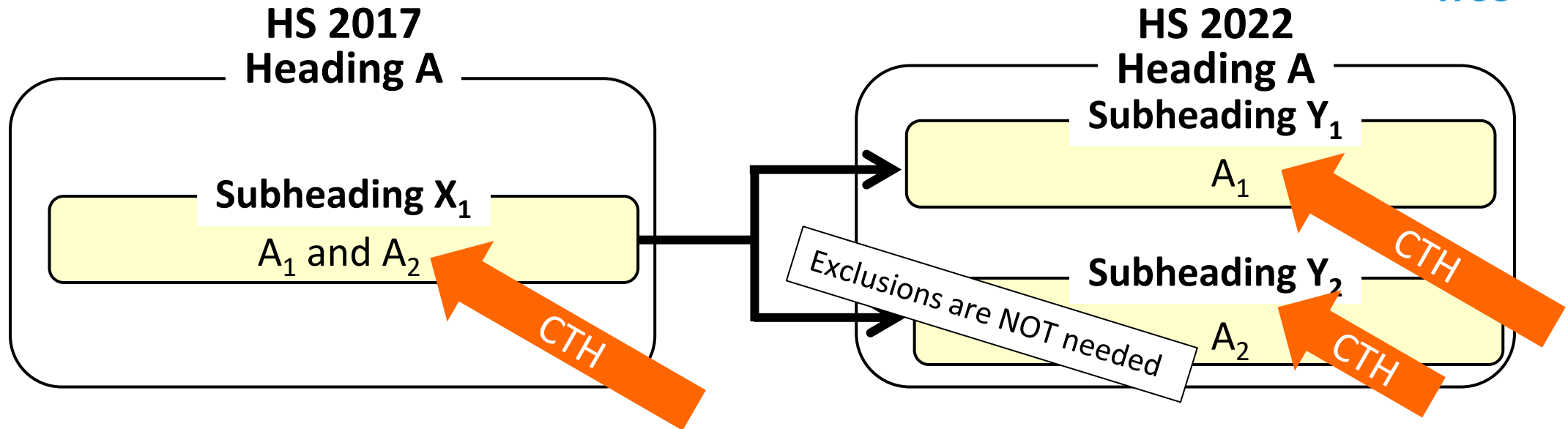

The exclusions are not needed if the extent of transposition caused by an HS amendment is less than that of the changes required by the original origin criteria (The exclusions make no sense).

In this example,

The extent of transposition caused by an HS amendment : **within** heading A → Subheading level

The changes required by the original origin criteria : **change from outside** heading A → Heading level

Origin Criterion (original)	Category of good	HS code (older edition)	HS code (later edition)	Category of good	Origin Criteria (technically updated)
CTH	A ₁ , A ₂	X ₁	Y ₁	A ₁	CTH
			Y ₂	A ₂	CTH

Basic Method

2) Merging of subheadings

Origin Criterion (original)	Category of good	HS code (older edition)		HS code (later edition)	Category of good	Origin Criteria (technically updated)
CTC ₁	A	X ₁	→	Y ₁	A, B	(A)CTC ₁ ; <u>or change from B</u>
CTC ₂	B	X ₂	→			(B)CTC ₂ ; <u>or change from A</u>



- In order to maintain the original requirements, goods of categories A and B need to have different origin criteria and the change from the other category is allowed as an origin conferring transformation, as the case may be.
- However, where the extent of transposition caused by an HS amendment is less than that of changes required by the original origin criteria, the additional descriptions **need to be deleted**.

Example 3: CTSH (Change in Tariff Subheading) criterion

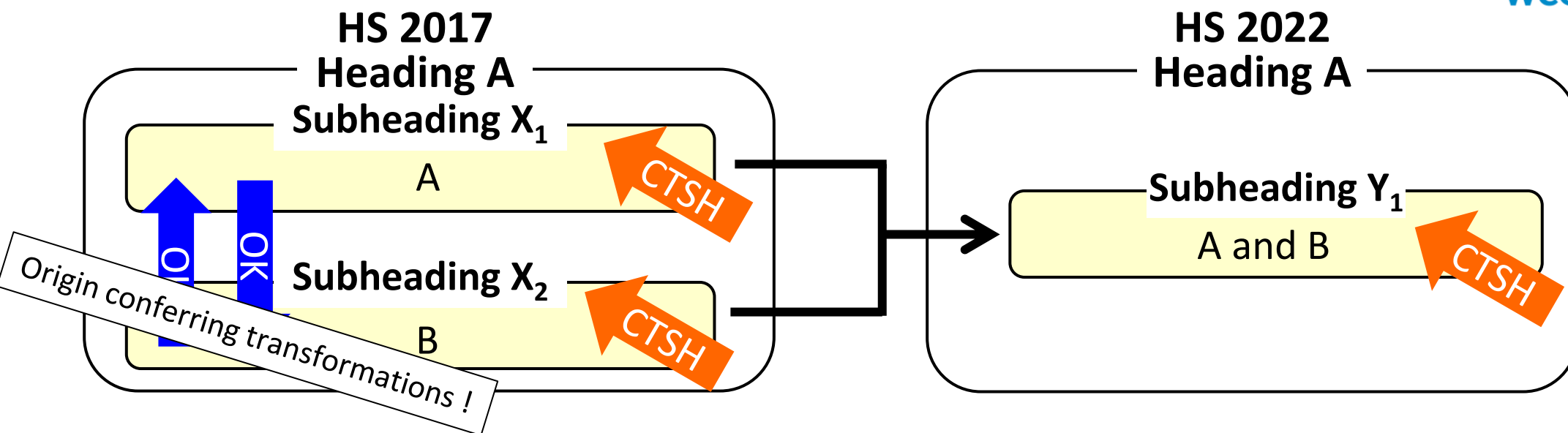

Since goods of categories A and B belonged to different subheadings, manufacture from A to B and manufacture from B to A are considered as origin conferring transformations. Therefore, alternative origin criteria should be added to the origin criteria for new subheading Y₁.

Origin Criterion (original)	Category of good	HS code (older edition)	HS code (later edition)	Category of good	Origin Criteria (technically updated)
CTSH	A	X ₁	Y ₁	A, B	(A ₁) CTSH; <u>or change from B</u>
CTSH	B	X ₂			(A ₂) CTSH; <u>or change from A</u>

Example 4: CTH (Change in Tariff Heading) criterion

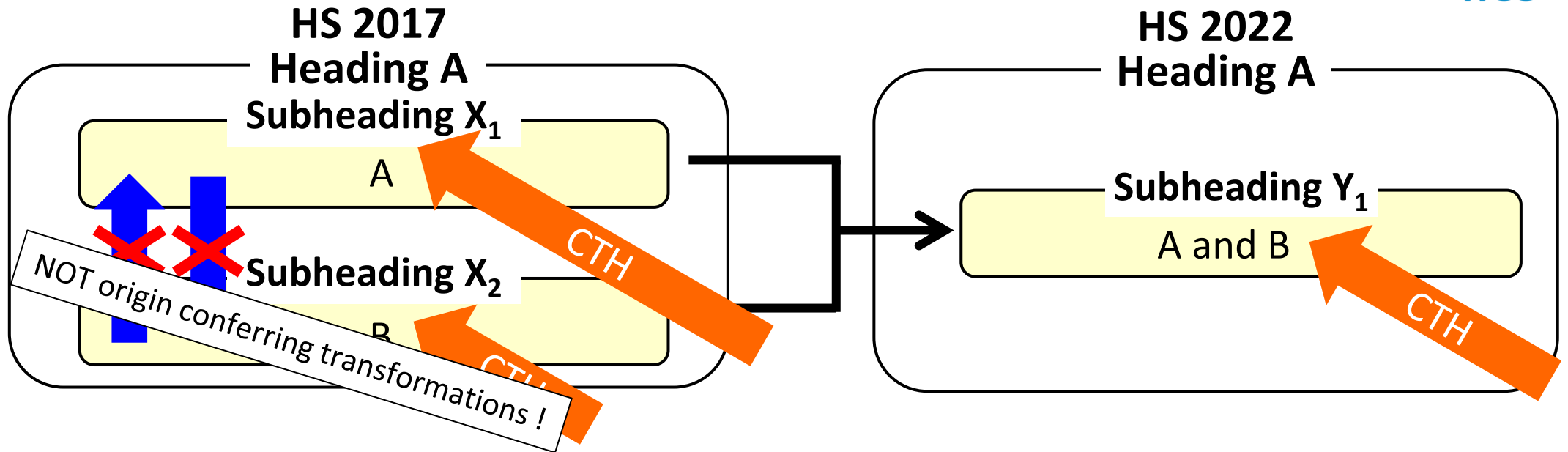

The alternative origin criteria **cannot be added** (need to be deleted) where the extent of transposition caused by an HS amendment is less than that of changes required by the original origin criteria.

Origin Criterion (original)	Category of good	HS code (older edition)	HS code (later edition)	Category of good	Origin Criteria (technically updated)
CTH	A	X ₁	Y ₁	A, B	CTH
CTH	B	X ₂			

Possibility for simplification of Rules of Origin

In some cases, technically updated origin criteria are too complicated and not user-friendly.

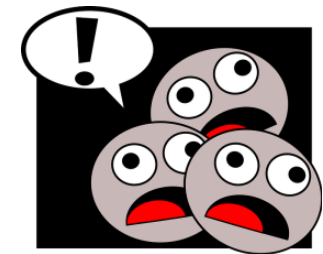

Consider **simplifications** by deleting descriptions about **technically or physically impossible changes**.

Example 5: Creation of subheading 0603.15 (lilies)

Origin Criterion (original)	Description	HS 2007		HS 2012	Description	Origin Criteria (technically updated)
CTSH	-- Other	0603.19	→	0603.15	-- Lilies (<i>Lilium spp.</i>)	CTSH
			→	0603.19	-- Other	CTSH

Impossible change! → ***Can be simplified***

Attention

Technical knowledge may be required in order to determine whether the processing is technically or physically impossible.



Table of Content



1. Introduction

2. Relationship to the HS

3. Necessity to consider if there is a need for a technical update

4. WCO Guide for the Technical Update of Preferential Rules of Origin

5. Method for the Technical Update

6. Summary

SUMMARY



Consistent structure of the HS and Rules of Origin

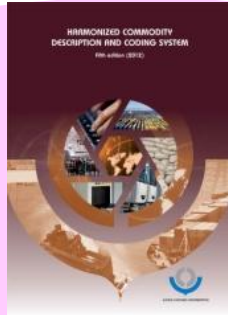

Classification
(HS 2022)
Latest edition



Rules of Origin of FTAs
(HS 2022)
Latest edition

- Prevent misapplication of Rules of Origin
- Facilitate origin determination
- Allow Customs to enhance their risk management of origin



Ensure efficient and effective revenue collection

SUMMARY



WCO Guide for Technical Update of Preferential Rules of Origin

Assist Members in the technical update of their existing Rules of Origin



SUMMARY

How much work is required for the technical update of Rules of Origin?



SUMMARY



❖ ***Not all the HS codes are affected by HS amendments***

HS 2007 Amendments : 766 / 5,224 subheadings (HS 2002)

HS 2012 Amendments : 305 / 5,052 subheadings (HS 2007)

HS 2017 Amendments : 292 / 5,205 subheadings (HS 2012)

HS 2022 Amendments : 351 / 5,387 subheadings (HS 2017)

HS 2022 has 5,612 Subheadings

* The numbers above do not include cases where subheadings are not specified in the Correlation Tables.

❖ ***In many cases, technical update can be done with no change in the origin criteria (i.e. no need for update)***

- Where an origin criterion requires a change which is bigger than the extent of transposition caused by the HS amendment

(Transposition by HS amendment) < (Origin criteria)

e.g. (Subheading level) < (CTH)

- Where an additional description (exclusion or additional description) of the updated criterion is an impossible change





**World Customs
Organization**

THANK YOU

Origin sub- directorate
Tariff and Trade Affairs Directorate
World Customs Organization
ori@wcoomd.org

